



### ■ Features

- ※ 100~305VAC input range
- ※ Efficiency up to 91%
- ※ Constant voltage mode + constant current mode output
- ※ IP67 waterproof rating, can be installed outdoors and indoors
- ※ Protections: SCP, OTP, OVP
- ※ Output internal potentiometer adjustment, three-in-one dimming
- ※ Surge Protection: L/N-PE: 6KV, L-N 4KV
- ※ Lifetime > 50000 hours

### ■ Applications

- ※ Led Strip lights
- ※ Led Wall Washer
- ※ Led Linear Lights
- ※ Led Underwater Lights
- ※ Led Neon Lights
- ※ Led Stage lights
- ※ Led Underground Lights
- ※ Led Module Lights

### Description

TLG-200V-A series is a 200W LED AC to DC power supply with constant current output and constant voltage output design as its main features. This series of models can work in the input voltage is 90--305VAC, and a variety of models with output rated voltages between 12V--54V are available. Has a high conversion efficiency of up to 90%, using no the fan is designed to work in the case temperature range of -40 °C to + 80 °C under natural air cooling and heat dissipation. Metal shell and IP67 high protection level design can make TLG-200V-A is suitable for outdoor or indoor applications. TLG-200V-A is equipped with a variety of functional options (such as multiple dimming methods) to provide the best light system Design flexibility.

### Model Encoding

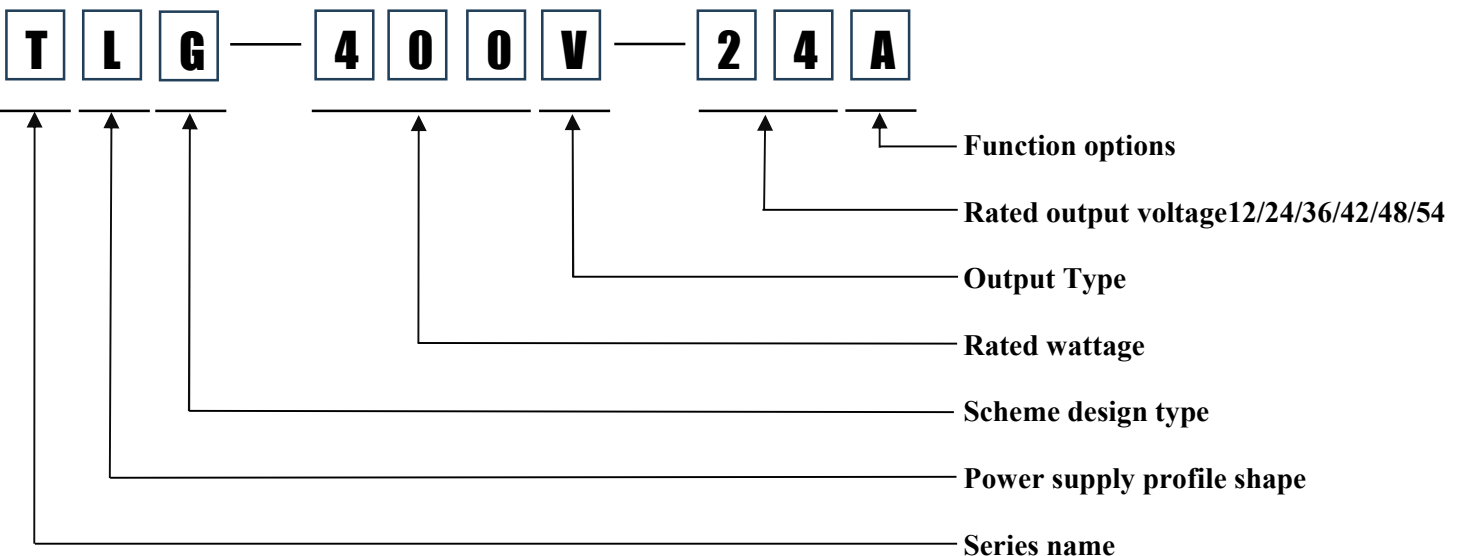

## ※ SPECIFICATION

MODEL		TLG-200V-12A	TLG-200V-24A	TLG-200V-36A	TLG-200V-42A	TLG-200V-54A
INPUT	Voltage Range	100-305VAC				
	Frequency Range	47-63Hz				
	Power Factor	PF $\geq$ 0.98/100VAC, PF $\geq$ 0.95/220VAC, PF $\geq$ 0.92/277VAC @full load				
	Efficiency	85.00%	87.00%	88.00%	90.00%	90.50%
	AC Current	1.75A/115VAC / 0.87A/230VAC / 0.72A/277VAC				
	Inrush Current	25Amax.@Full Load,230VAC,Cold Start				
	Circuit Breaker	2 units (circuit breaker of type B) / 3 units (circuit breaker of type C) at 230VAC				
	Leakage Current	<1mA / 277VAC				
OUTPUT	DC voltage	12VDC	24VDC	36VDC	42VDC	54VDC
	Output rated current	8-12V	14.4-24VA	21.6-36VA	25.2-42A	32.4-54A
	Rated power	200W	200W	200W	200W	200W
	Ripple & Noise	120mVp-p	150mVp-p	200mVp-p	300mVp-p	300mVp-p
	Voltage adjustment	10.5-14V	22-27V	33-40V	40-46V	49-58V
	Current adjustment	1.5-2.5A	0.75-1.25A	0.5-0.84A	0.4-0.72A	0.3-0.56A
	Voltage accuracy	$\pm$ 2.0%	$\pm$ 1.0%	$\pm$ 1.0%	$\pm$ 1.0%	$\pm$ 1.0%
	Linear adjustment rate	$\pm$ 1.0%	$\pm$ 1.0%	$\pm$ 1.0%	$\pm$ 1.0%	$\pm$ 1.0%
	Load regulation ratio	$\pm$ 1.5%	$\pm$ 1.5%	$\pm$ 1.5%	$\pm$ 1.5%	$\pm$ 1.5%
	Start, rise time	800ms,80ms/115VAC, 500ms,50ms/230VAC@full load				
	Hold time (typ.)	30ms/115VAC, 230VAC				
PROTECTION	Over Current	95-110%, constant current limit, automatic recovery after abnormal load conditions are removed				
	Over Voltage Protection	16-18V	28-35V	41-49V	48-58V	59-68V
	Short circuit Protection	Hiccup mode, which can be automatically restored after the abnormal load condition is removed				
	Over Temperature	Turn off output voltage, restart recovery				
ENVIRONMENT	Working Temp	Tcase=-40°C...+70°C				
	Max. Case Temp	Tcase= +90°C				
	Working Humidity	20-95% RH,No condensation				
	Storage Temp	-40...+80°C, 10...95% RH,No condensation				
	Vibration	10-500Hz,2G10min./1cycle,60min.eachalongX,Y,Zaxes				
SAFETY & EMC	Safety Standards	Conform UL8750(type"TL"), CSA C22.2 No. 250.0-08, BS EN/EN/AS/NZS 61347-1, BS EN/EN/AS/NZS 61347-2-13, independent, GB19510.1, GB19510.14, EAC TPTC 004, KC61347-1, IP67				
	Withstand Voltage	I/P-O/P:3.75KVAC I/P-FG:2.0KVAC O/P-FG:1.5KVAC				
	Insulation impedance	I/P-O/P, I/P-FG, O/P-FG:100M Ohms / 500VDC / 25°C/ 70% RH				
	Electromagnetic Compatibility	Conform BS EN/EN55015, BS EN/EN61000-3-2 Class C (@Load>60%); BS EN/EN61000-3-3,GB/T 17743, GB17625.1, EAC TPTC 020				
	Electromagnetic compatibility immunity	Conform BS EN/EN61000-4-2,3,4,5,6,8,11; BS EN/EN61547,Light industry standards (Surge immunity: wire-to-ground4KV,Line-to-line:2KV), EAC TPTC 020				
OTHERS	MTBF	>3000K hrs. MIL-HDBK-217F (25°C)				
	Dimension	(L) 210 mm*(W) 68 mm*(H) 40 mm				
NOTE	<p>1: Please refer to "LED Module Driving Method".</p> <p>2: Ripple and noise measurement method: Use a 12 "twisted pair, and the terminals must be connected in parallel with 0.1 uf and 47uf capacitors, and measure at 20MHZ bandwidth.</p> <p>3: Type B only adjustable (through internal potential adjustment).</p> <p>4: Accuracy: including setting error, linear adjustment rate, and load adjustment rate.</p> <p>5: Unless otherwise specified, all specifications are measured at 230VAC input, rated load, and 25 °C ambient temperature.</p> <p>6: The power supply is regarded as a component used in combination with the terminal equipment. Because the EMC is affected by the entire device, the terminal equipment manufacturer needs to re-confirm the EMC of the entire device.</p>					

※ **BLOCK DIAGRAM**

Oscillation frequency 100KHZ

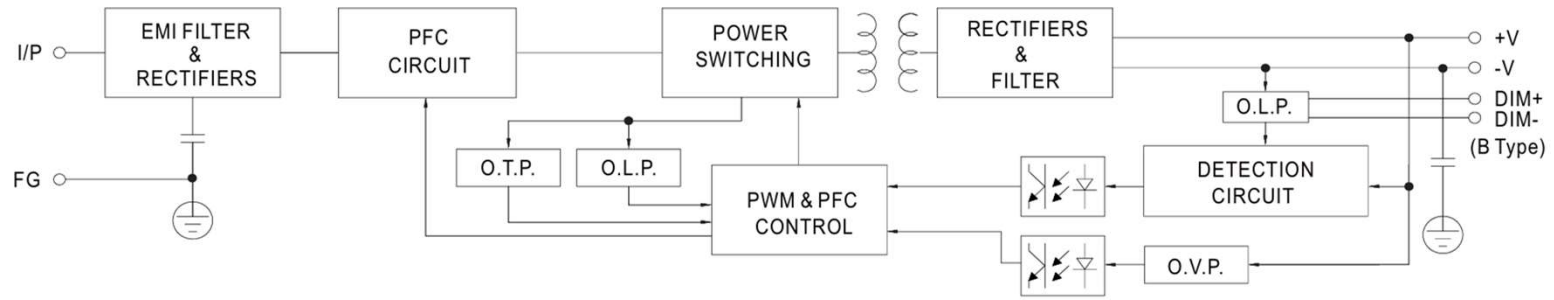

※ **LED DRIVING MODE**

This series is able to work in either Constant Current mode (a direct drive way) or Constant Voltage mode (usually through additional DC/DC driver) to drive the LEDs

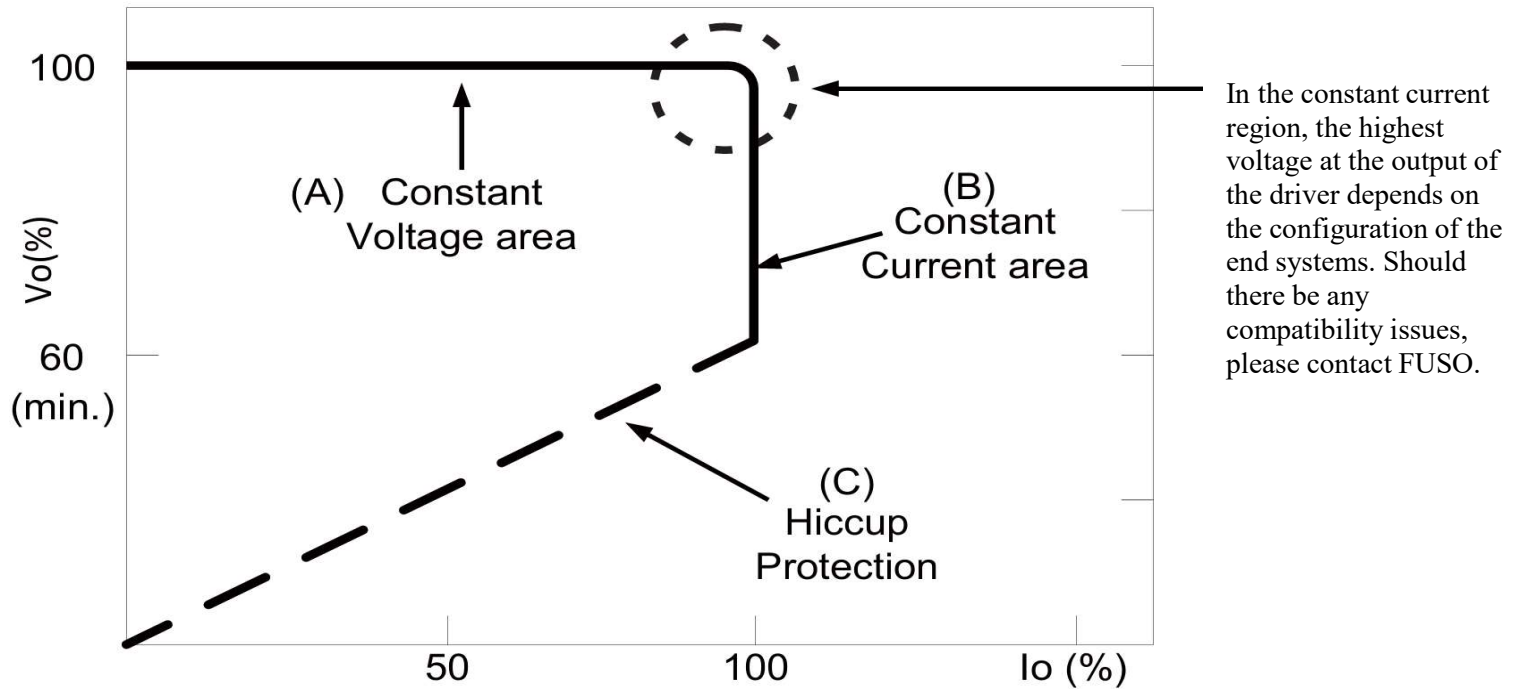

In the constant current region, the highest voltage at the output of the driver depends on the configuration of the end systems. Should there be any compatibility issues, please contact FUSO.

Typical output current normalized by rated current (%)

※ **DIMMING OPERATION**



※ **3 in 1 dimming function (for A/B-Type)**

- \* Output constant current level can be adjusted by applying one of the three methodologies between DIM+ and DIM-: 1 ~ 10VDC, or 10V PWM signal or resistance.
- \* Direct connecting to LEDs is suggested. It is not suitable to be used with additional drivers.
- \* Dimming source current from power supply: 100μA (typ).

※ **Applying additive 1~10VDC**

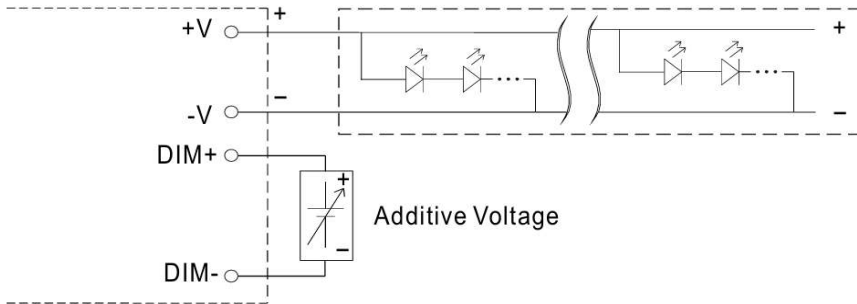

DO NOT connect "DIM- to -V

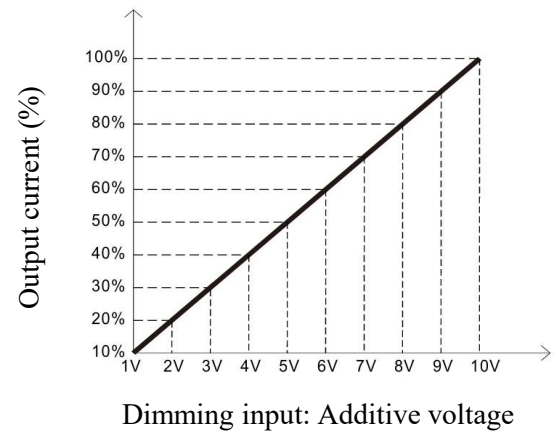

※ **Applying additive 10V PWM signal (frequency range 100Hz ~ 3KHz):**

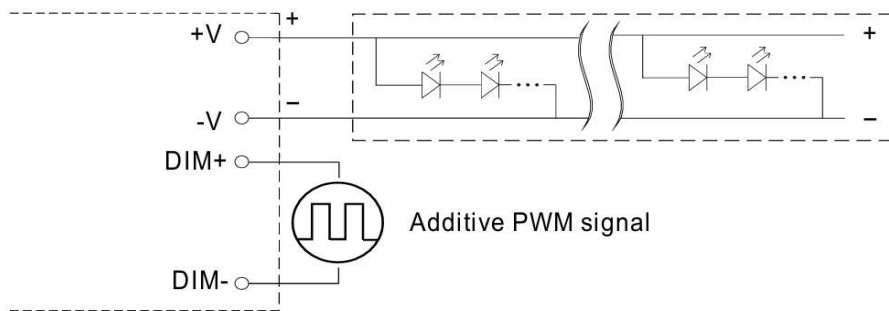

DO NOT connect "DIM- to -V

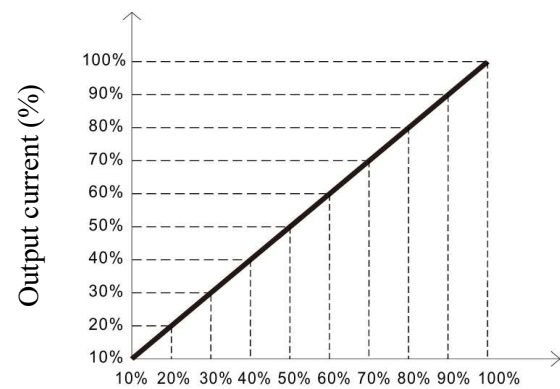

※ **Applying additive resistance:**

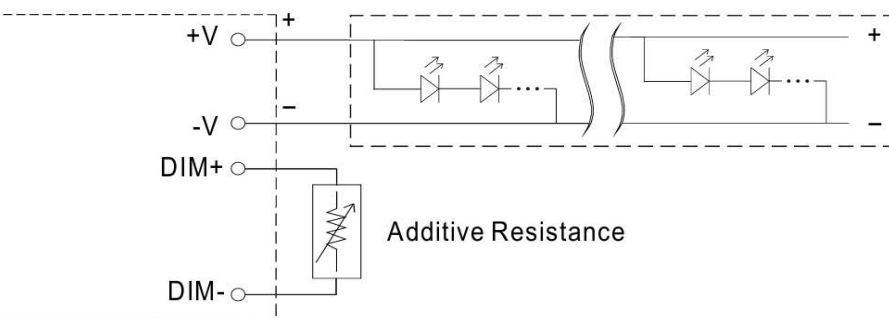

DO NOT connect "DIM- to -V

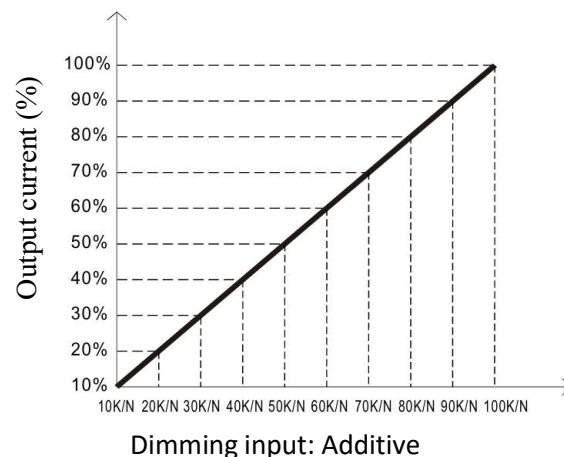

※ **OUTPUT LOAD vs TEMPERATURE(No.10)**

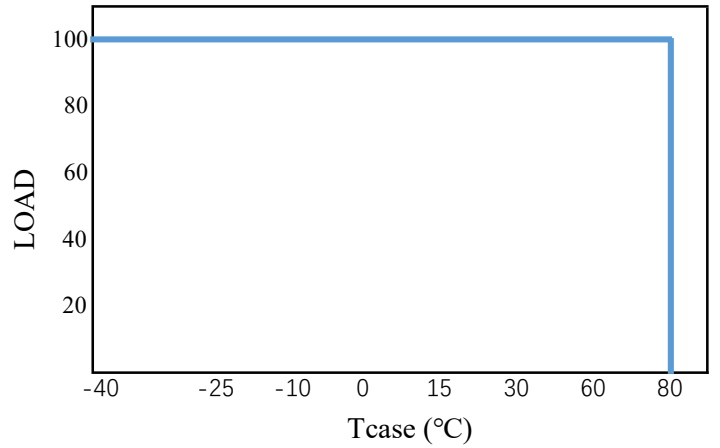
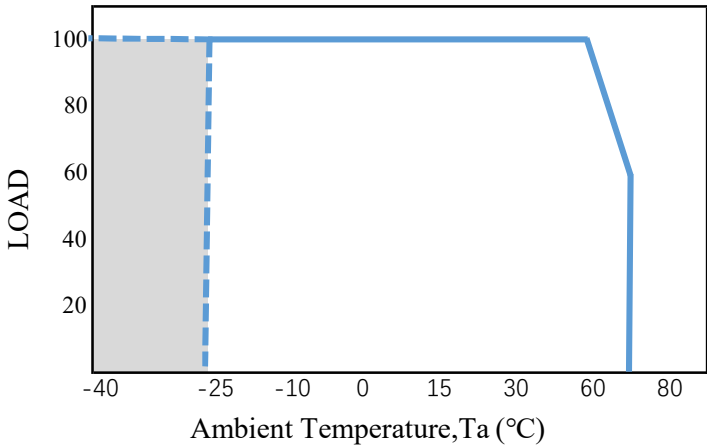

※ **STATIC CHARACTERISTICS**

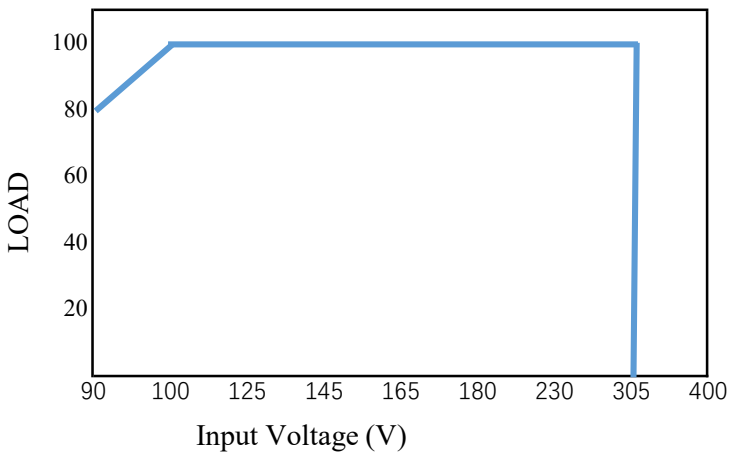

※ **POWER FACTOR(PF) CHARACTERISTIC**

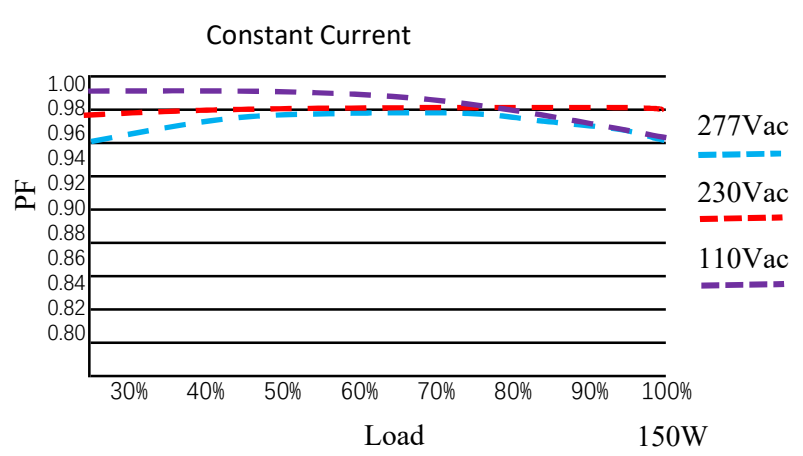

※ **TOTAL HARMONIC DISTORTION (THD)**

48V Model, Tcase at 70°C

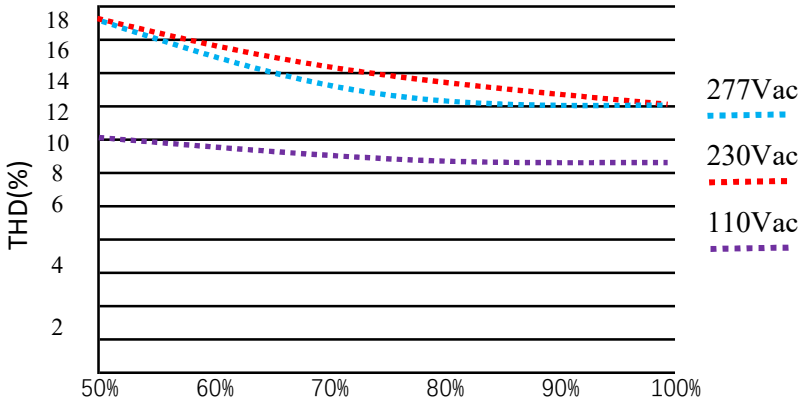

※ **EFFICIENCY vs LOAD**

48V Model, Tcase at 70°C

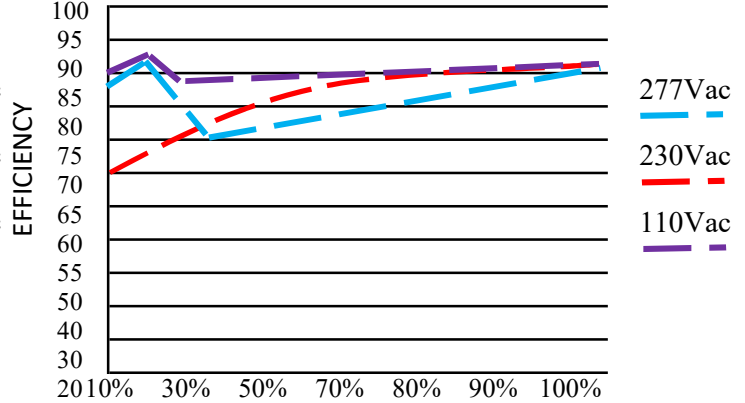

※ **LIFE TIME**

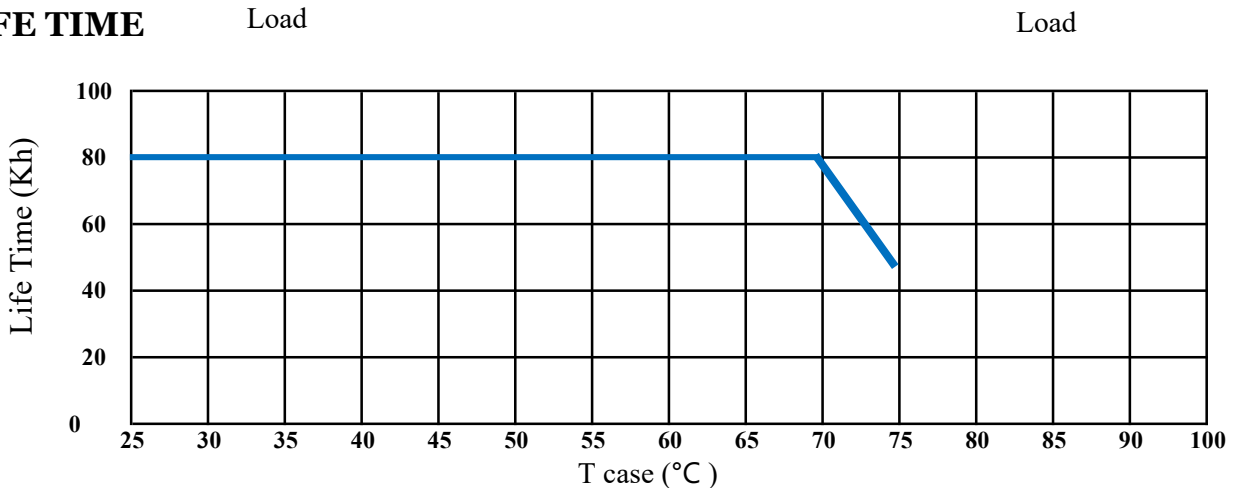

**MECHANICAL SPECIFICATION(Unit: mm)**

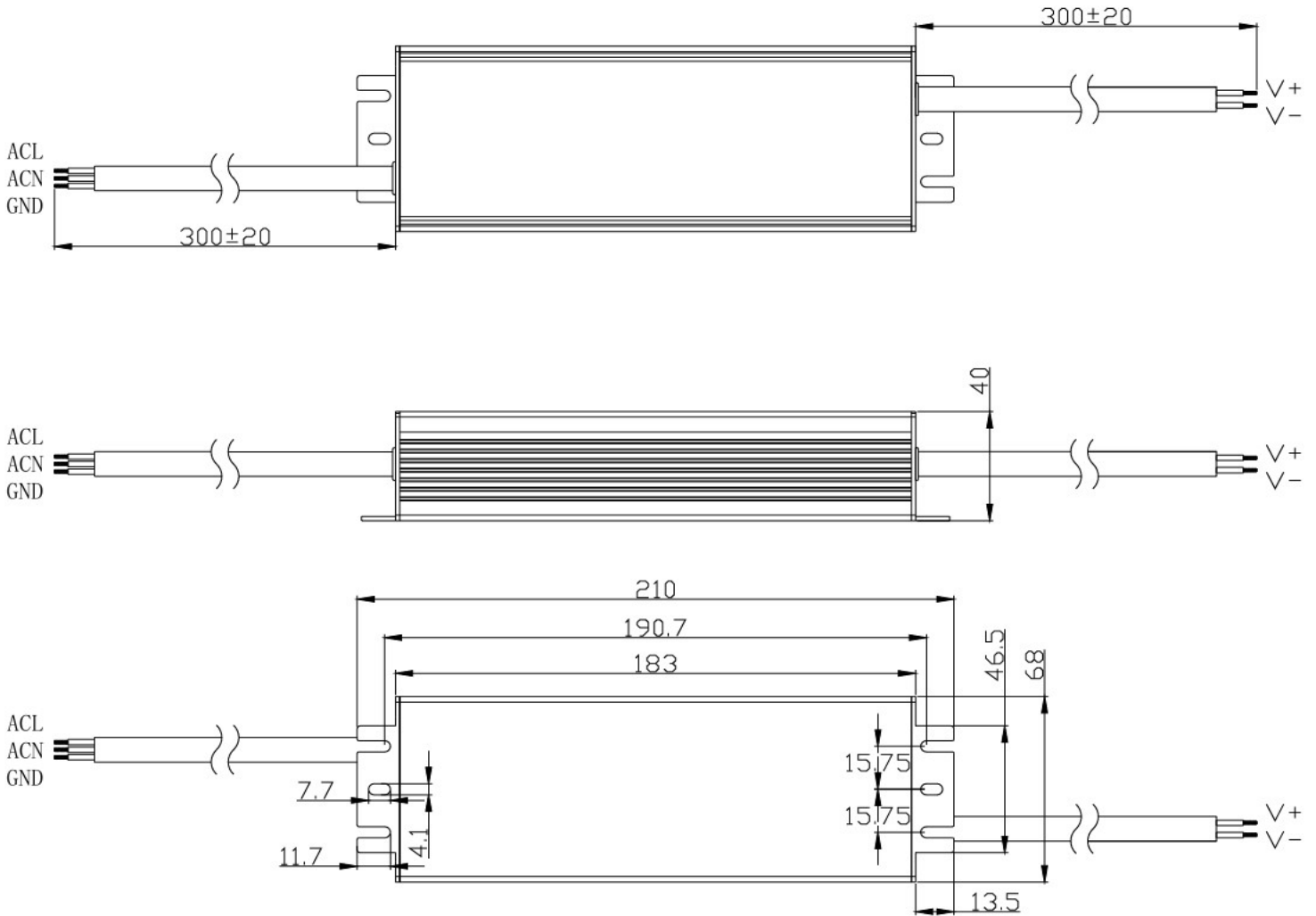

**NOTE**

<b>Input Wire</b>	BROWN: L ; BLUE: N ; Global certified wire: SJOW, HO5RN-F/YZW/PNCTF 3*17AWG 105°C 3*1.0mm, YELLOW&GREEN:
<b>Output Wire</b>	RED:V+ ;BLACK:V- Global certified wire: SJOW, HO5RN-F/ZW/PNCTF 2*17AWG 105 'C 2*1.0mm
<b>Grounding wire</b>	YELLOW&GREEN:Ground Wire

**PHYSICAL PICTURES OF PRODUCTS**



**PRECAUTIONS:**

When the dimming cable is not in use, insulate and waterproof it.

It is suitable for transportation by vehicles, ships and airplanes. During transportation,

It should be sheltered, sunscreen and loaded and unloaded in a civilized way.

Product storage shall comply with the provisions of GB3873-83.

Products with a storage period of more than 1 year should be re-inspected and can only be used after qualifying.

The product complies with the EU RoHS Directive (2011/65/EU) and the European Parliament's amendments 2015/863/EU.